

---

## Part IV. An Experimental Study of the Collapse of Liquid Columns on a Rigid Horizontal Plane

J. C. Martin and W. J. Moyce

*Phil. Trans. R. Soc. Lond. A* 1952 **244**, 312-324

doi: 10.1098/rsta.1952.0006

---

### Email alerting service

Receive free email alerts when new articles cite this article - sign up in the box at the top right-hand corner of the article or click [here](#)

---

To subscribe to *Phil. Trans. R. Soc. Lond. A* go to: <http://rsta.royalsocietypublishing.org/subscriptions>

---

## PART IV. AN EXPERIMENTAL STUDY OF THE COLLAPSE OF LIQUID COLUMNS ON A RIGID HORIZONTAL PLANE

BY J. C. MARTIN AND W. J. MOYCE

## CONTENTS

	PAGE		PAGE
1. Introduction	312	4. Results	314
2. Scaling laws	312	5. Discussion of results	320
3. Experimental method	313		

An experimental study has been made of some aspects of the phenomena accompanying the collapse of liquid columns on to a rigid horizontal plane with air as the outer medium. The cases covered include the two-dimensional collapse of rectangular and semicircular sections, and the three-dimensional axial collapse of right circular cylinders.

As the columns collapsed, the fluid spread across the horizontal plane, attaining a maximum velocity, which, in the two-dimensional cases, was proportional to the square root of the original height.

It was not clear whether this proportionality would hold for the axial collapse of cylinders. If it did, then the factor of proportionality would be some 25 % lower.

In the two-dimensional cases the top of the residual column accelerated downwards to a maximum velocity proportional to the square root of the product of the original height and the original height to base ratio. The nature of the subsequent retardation indicated that the downward velocity probably approached zero asymptotically with time.

## 1. INTRODUCTION

The experiments to be described in this paper were carried out in order to supplement the theoretical treatment of the collapse of fluid columns *in vacuo*. In these experiments water was used as the fluid, and air was present as the outer medium. The density ratio between outer and inner media under these conditions is so small as to provide sufficient approximation to conditions of external vacuum, at least as far as bulk motions are concerned.

When a fluid column, initially at rest on a rigid horizontal plane, collapses on to that plane the fluid spreads out and the height of the column falls. We have examined the velocity of spread of the fluid and the rate of fall of the top of the column during this process. The cases covered include the two-dimensional collapse of rectangular and semicircular sections, and the axially symmetrical collapse of vertical circular cylinders.

The experiments were such as to give an approximation to the idealized phenomena, it being a matter of great difficulty, if not an impossibility, to constrain the initial unstable column and then release the constraint without affecting the subsequent motion.

## 2. SCALING LAWS

During the collapse of a perfect fluid column, the following relations hold:

$$z/a = F_1[n^2, t(g/a)^{\frac{1}{2}}], \quad (1)$$

$$\eta/a = F_2[n^2, t(g/a)^{\frac{1}{2}}], \quad (2)$$

where  $n^2a$  = original height of column,

$a$  = a dimension characteristic of the column base (radius of base in axially symmetrical cases and semi-base length in plane symmetrical cases),

$z$  = distance of surge front from axis or plane of symmetry,

$\eta$  = height of residual column,

$g$  = acceleration due to gravity,

$t$  = time.

It is therefore convenient to present the results of experiments in units of the non-dimensional quantities given by the terms of equations (1) and (2), or combinations of such terms.

The following notation is used:

$$Z = z/a,$$

$$H = \eta/an^2,$$

$$T = nt(g/a)^{\frac{1}{2}},$$

$$\tau = t(g/a)^{\frac{1}{2}},$$

$$U = dZ/dT.$$

Providing the experimental observations were not largely influenced by viscosity and surface tension at the scale employed, results presented in terms of the above parameters would be applicable, to a good approximation, to the phenomena on a larger scale. Since it is possible to simulate the motion of the Bikini surge by means of two-fluid model experiments (part V) it appears likely that scaling up of the results is permissible.

### 3. EXPERIMENTAL METHOD

The apparatus was similar in principle for all the shapes of column studied. The fluid column was constrained by a very thin waxed paper diaphragm held in position by a thin film of beeswax on a metal strip forming part of the fluid reservoir. The brief passage through this strip of a heavy current obtained by shorting momentarily a 36 V bank of car batteries was used to free the waxed paper and thus allow motion to begin.

The two-dimensional collapse of rectangular sections was studied in the form of the emptying of a rectangular corner, the motions being similar because of plane symmetry. For the two-dimensional collapse of a semicircular section the full section was employed. In these two-dimensional cases the emergent fluid was constrained to run along a channel. To adapt the method to the study of the collapse of cylinders, the initial fluid shape took the form of a vertical sector of a cylinder, the fluid being constrained to run over a fan-shaped channel.

It is proposed to describe the apparatus used for rectangular sections, the adaptation of the principle to other shapes being obvious. Figure 1 is a diagram of this apparatus. The Perspex reservoir cell on the left was rectangular in shape, and of internal dimensions  $2\frac{1}{4} \times 2\frac{1}{4} \times 5$  in. high. One face of the cell was left open and a card strip was stuck to the Perspex edges thus exposed. This card strip prevented damage to the Perspex due to heat from the  $\frac{1}{8} \times 0.012$  in. steel heater strip. This steel strip, with paper diaphragm attached, was fixed to the card strip with a cellulose cement.

A simple Perspex channel with a width slightly greater than that of the reservoir was used to receive the outflowing liquid. The extra width facilitated free movement of the released diaphragm. Transverse lines scored in the base of the channel assisted subsequent assessment of the photographic records. The channel was placed against the reservoir as shown in the figure. Water was introduced to the required level in the reservoir, and released by feeding the heavy current through a knife switch, to the tags of the heater strip. The most rapid possible manual closing and reopening of the switch was found sufficient to release the paper. A small pea lamp, in parallel with the heater, gave an indication of the time of current application.

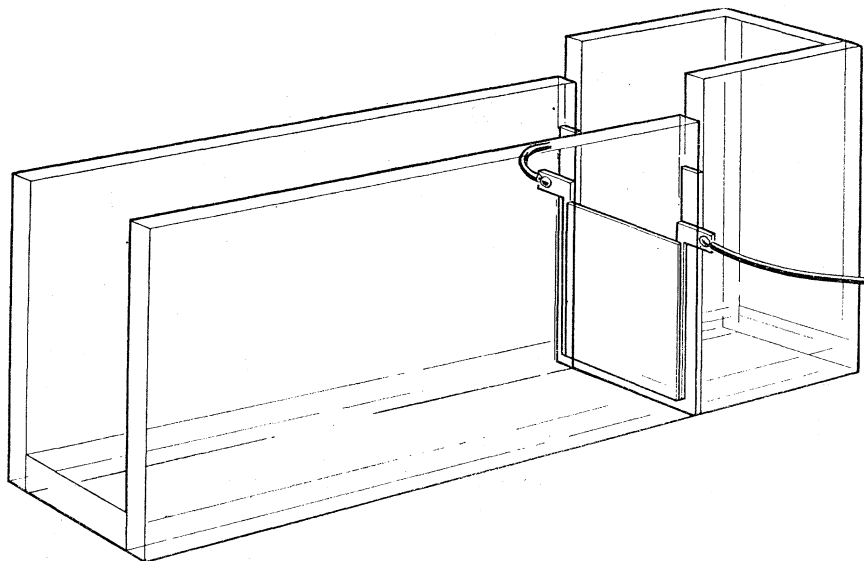

FIGURE 1. Diagram of typical apparatus.

The motion of the fluid was recorded by ciné photography at about 300 frames per second, using either a 16 mm. Zeiss Zeitlupe camera or a 35 mm. Vinten 300. Timing marks from a standard oscillator were simultaneously recorded on the film margin. An overhead view, obtained by the use of a tilted mirror, was found convenient for recording the motion of the surge front.

#### 4. RESULTS

Side views of the phenomena, such as are shown in figure 2 (which portrays the  $n^2 = 1$  rectangular section), indicate a qualitative similarity in the motions of all the cases studied.

Quantitatively, the results obtained are set out in tables 1 to 7. It was not found possible, during the experiments, to record the exact time of beginning of motion. The time of application of the current to the heater, as shown by the small lamp mentioned above, can only give an early limit to zero time. In view of the very heavy currents drawn from the batteries and the nature of the diaphragm construction it is unlikely that any great significance can be given to the relationship between the time of lighting of the lamp and the subsequent fluid motion. No doubt further improvements in technique could be made, but in the results tabulated here the times have been normalized so as to give, for any given record in a series, the same time reading at a finite extent of spread. This time is of the order of magnitude of that which elapsed between application of the heating current and attainment of the degree of spread in question.



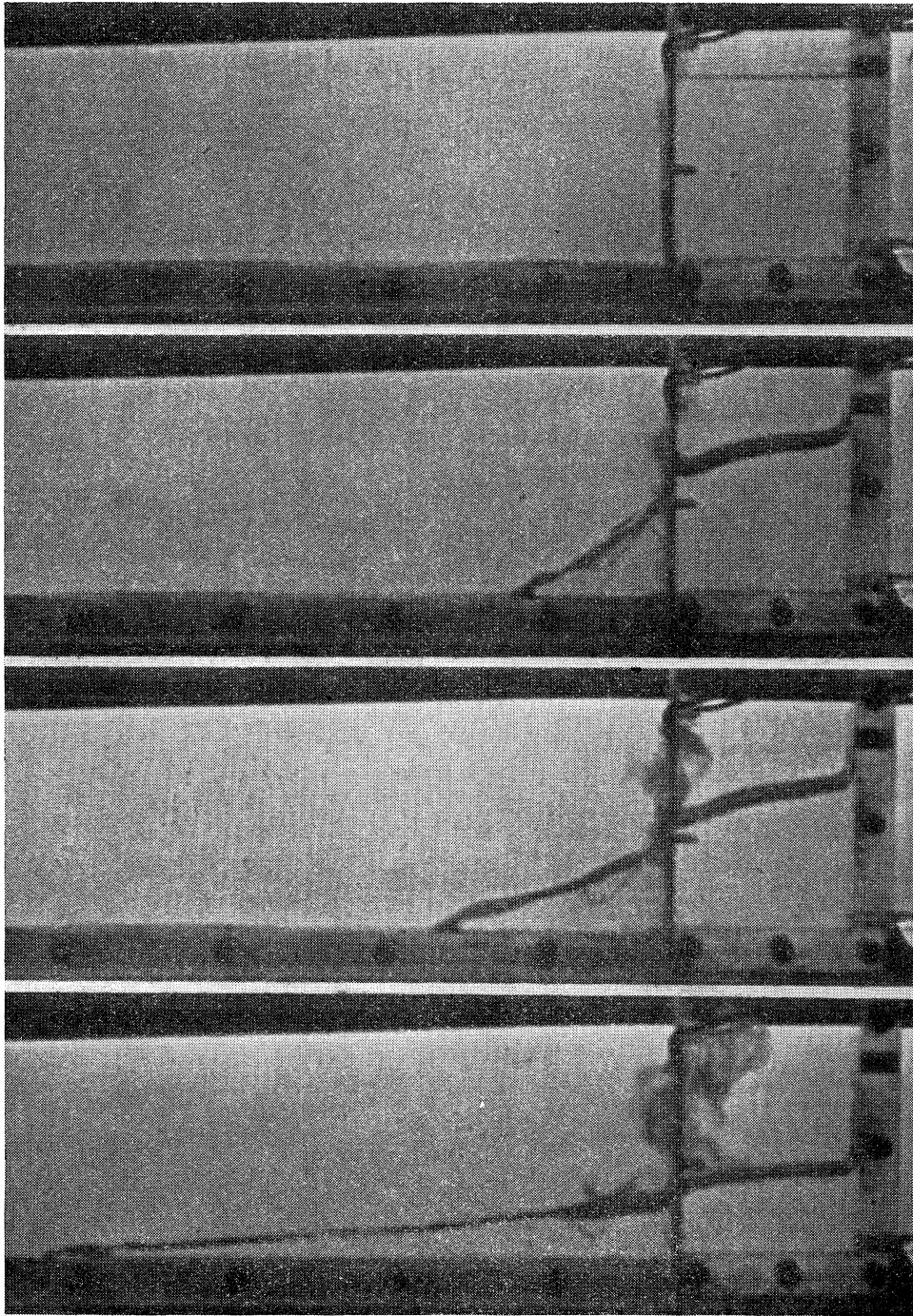

FIGURE 2. Two dimensional collapse of  $n^2=1$  section.

The tables present the following data:

- Table 1. Rectangular section  $n^2 = 1$ ;  $Z$  against  $T$ .  $a = 2\frac{1}{4}$  and  $4\frac{1}{2}$  in.
- Table 2. Rectangular section  $n^2 = 2$ ;  $Z$  against  $T$ .  $a = 1\frac{1}{8}$  and  $2\frac{1}{4}$  in.
- Table 3. Rectangular section  $n^2 = 4$ ;  $Z$  against  $T$ .  $a = 1\frac{1}{8}$  in.
- Table 4. Semicircular section.  $Z$  against  $T$ .  $a = 2$  in.
- Table 5. Vertical circular cylinder  $n^2 = 1$  and  $2$ .  $Z$  against  $T$ .  $a = 2\frac{1}{4}$  in.
- Table 6. Rectangular sections  $n^2 = 1, 2$  and  $4$ .  $H$  against  $\tau$ .
- Table 7. Semicircular section.  $H$  against  $\tau$ .







TABLE 3. RECTANGULAR SECTION, PLANE SYMMETRY,  $\eta^2=4$

Z	$T = \eta t(g/a)^{\frac{1}{2}}, a = 1\frac{1}{2}$ in.										mean
1.00	2.00	2.00	2.00	2.00	2.00	2.00	2.00	2.00	2.00	2.00	—
1.44*	2.58	2.48	2.52	2.44	2.44	2.78	2.74	2.70	2.60	2.62	2.00
1.89	3.08	3.04	3.00	3.10	2.88	3.22	3.38	3.26	3.22	2.62	2.62
2.33	3.52	3.56	3.52	3.76	3.78	3.78	3.82	3.70	3.66	—	3.16
2.78	3.96	4.08	3.96	4.04	4.14	4.14	4.18	4.14	4.12	3.86	3.64
3.22	4.44	4.52	4.38	4.50	4.52	4.52	4.56	4.60	4.60	—	4.04
3.67	4.82	5.00	4.82	4.82	4.78	4.96	5.00	4.96	5.12	5.16	4.48
4.11	5.34	5.44	5.18	5.24	5.32	5.44	5.44	5.40	5.48	—	4.92
4.56	5.78	5.92	5.56	5.60	5.70	5.82	5.82	5.78	5.92	—	5.30
5.00	6.22	6.38	6.00	6.00	6.06	6.16	6.16	6.16	6.34	5.92	5.72
5.44	6.60	6.78	6.38	6.38	6.44	6.52	6.52	6.52	6.74	—	6.12
5.89	6.96	7.22	6.74	6.68	6.70	6.82	6.90	6.92	7.12	—	6.50
6.33	7.30	7.56	7.14	7.04	7.08	7.22	7.30	7.30	7.30	—	6.88
6.78	—	7.92	7.52	7.38	7.44	7.58	7.60	7.60	7.78	7.88	7.22
7.22	—	8.22	7.82	—	7.78	7.96	7.86	7.92	8.16	—	7.60
7.67	—	—	—	—	—	—	—	—	—	—	7.92
9.0	—	—	—	—	—	—	—	—	—	9.20	9.06
11.0	—	—	—	—	—	—	—	—	—	10.4	10.4
13.0	—	—	—	—	—	—	—	—	—	11.8	11.8
15.0	—	—	—	—	—	—	—	—	—	13.1	13.0
17.0	—	—	—	—	—	—	—	—	—	14.5	14.4
19.0	—	—	—	—	—	—	—	—	—	15.9	15.7
21.0	—	—	—	—	—	—	—	—	—	17.3	17.1
23.0	—	—	—	—	—	—	—	—	—	18.8	18.6
25.0	—	—	—	—	—	—	—	—	—	20.4	20.0
27.0	—	—	—	—	—	—	—	—	—	21.9	21.5

\*  $T$  normalized at this value of  $Z$  except in records marked †.

† No  $T$  record being available at  $Z=1.44$ ,  $T$  normalized at  $Z=1.89$  to mean  $T$  value for other records. Thickness of section  $2\frac{1}{4}$  in. in all cases.



## PART IV. COLLAPSE OF FREE LIQUID COLUMNS

319

TABLE 4. SEMICIRCULAR SECTION PLANE SYMMETRY. RADIUS OF SECTION 2 IN.

$$T = nt(g/a)^{\frac{1}{2}}$$

$$n^2 = 1, a = 2 \text{ in.}$$

Z				mean
1.0	—	—	—	—
1.1	0.63	0.66	0.67	0.65
1.2*	0.78	0.78	0.78	0.78
1.4	1.00	1.03	1.02	1.02
1.6	1.18	1.15	1.26	1.20
1.8	1.37	1.45	1.39	1.40
2.0	1.59	1.63	1.58	1.60
2.2	1.76	1.82	1.76	1.78
2.4	1.96	2.01	1.91	1.96
2.6	2.13	2.22	2.09	2.15
2.8	2.36	2.33	2.27	2.32
3.0	2.54	2.51	2.46	2.50
3.2	2.68	2.70	2.64	2.67
3.4	—	2.86	2.78	2.82
3.6	—	3.03	2.95	2.99
3.8	—	3.18	3.11	3.14
4.0	—	3.41	3.26	3.33

\*  $T$  normalized at this value of  $Z$ . Thickness of section  $2\frac{1}{4}$  in.

TABLE 5. VERTICAL CIRCULAR CYLINDER

$$T = nt(g/a)^{\frac{1}{2}}$$

Z	$n^2 = 1, a = 2\frac{1}{4} \text{ in.}$				$n^2 = 2, a = 2\frac{1}{4} \text{ in.}$			
				mean				mean
1.00	—	—	—	—	—	—	—	—
1.22	0.62	0.57	0.57	0.59	1.16	1.20	1.20	1.19
1.44*	0.80	0.80	0.80	0.80	1.50	1.50	1.50	1.50
1.67	1.03	0.97	1.02	1.01	1.68	1.73	1.75	1.73
1.89	1.19	1.14	1.19	1.17	1.87	1.92	1.98	1.92
2.11	1.38	1.30	1.35	1.34	—	2.18	2.18	2.18
2.33	1.54	1.49	1.57	1.53	2.29	2.40	2.40	2.36
2.56	1.72	1.66	1.73	1.70	2.52	2.62	2.62	2.59
2.78	1.89	1.84	1.92	1.88	2.72	2.81	2.81	2.79
3.00	2.02	2.02	2.09	2.04	2.88	3.01	3.00	2.97
3.22	2.21	2.22	2.27	2.23	3.11	3.24	3.22	3.20
3.44	2.39	2.37	2.44	2.40	3.32	3.39	3.41	3.38
3.67	2.55	2.56	2.65	2.59	3.55	3.61	3.59	3.58
3.89	2.73	2.74	2.83	2.77	3.73	3.79	3.76	3.76
4.11	2.94	2.94	3.03	2.97	3.92	4.02	3.97	3.97
4.33	3.13	3.14	3.25	3.17	—	—	—	—

\*  $T$  normalized at this value of  $Z$ .

The mean results from these tables are plotted as follows:

- tables 1, 2 and 3, figure 3;
- table 4, figure 4;
- table 5, figure 5;
- tables 6 and 7, figure 6.

TABLE 6. MOTION OF TOP OF COLUMN. RECTANGULAR SECTION, PLANE SYMMETRY

H	$\tau = t(g/a)^{\frac{1}{2}} = T/n$								
	$n^2 = 1, a = 2\frac{1}{4}$ in.			$n^2 = 2, a = 2\frac{1}{4}$ in.			$n^2 = 4, a = 1\frac{1}{8}$ in.		
			mean			mean			mean
1.00*	0	0	0	0	0	0	0	0	0
0.94	—	—	—	—	0.56	0.56	0.61	0.65	0.63
0.89	0.85	0.75	0.80	0.76	0.79	0.77	0.87	0.93	0.90
0.83	—	—	—	—	0.96	0.93	1.11	1.17	1.14
0.78	1.31	1.28	1.29	1.05	1.11	1.08	1.30	1.30	1.30
0.72	—	—	—	—	1.33	1.28	1.43	1.48	1.46
0.67	1.74	1.74	1.74	1.44	1.47	1.46	1.61	1.67	1.64
0.61	—	—	—	—	1.68	1.66	1.76	1.85	1.81
0.56	2.16	2.14	2.15	1.81	1.86	1.84	1.98	1.98	1.98
0.50	—	—	—	—	2.00	2.00	2.07	2.19	2.13
0.44	2.58	2.55	2.57	2.18	2.23	2.21	2.32	2.32	2.32
0.39	—	—	—	—	2.49	2.45	2.50	2.46	2.48
0.33	3.08	3.08	3.08	2.65	2.75	2.70	2.69	2.69	2.69
0.28	—	—	—	—	3.08	3.06	2.87	2.87	2.87
0.22	4.36	4.17	4.27	3.41	3.47	3.44	3.11	3.15	3.13
0.17	—	—	—	—	4.09	4.20	3.46	3.37	3.42
0.11	6.09	6.48	6.29	5.20	5.30	5.25	3.80	4.07	3.94
0.06	—	—	—	—	7.40	7.40	5.74	5.00	5.37
† motion began at or before $\tau = 0.2$					0.16				0.2

\*  $\tau = 0$  taken as the time when heater current was applied.

† As indicated by change in appearance of fluid meniscus in reservoir.

Thickness of section  $2\frac{1}{4}$  in. in all cases.

TABLE 7. MOTION OF TOP OF COLUMN. SEMICIRCULAR SECTION, PLANE SYMMETRY

H	$\tau = t(g/a)^{\frac{1}{2}} = T/n, n^2 = 1, a = 2$ in.							mean
1.0*	0	0	0	0	0	0	0	0
0.87	1.08	0.72	1.03	0.92	0.83	0.83	0.83	0.90
0.75	1.35	1.08	1.30	1.31	1.10	1.10	1.10	1.21
0.62	1.78	1.41	1.52	1.72	1.31	1.38	1.38	1.52
0.50	2.40	2.18	1.93	2.23	2.07	2.22	2.22	2.17
0.37	2.90	2.62	2.66	2.79	2.52	2.58	2.58	2.68
0.25	3.27	2.90	2.96	3.75	2.90	2.96	2.96	3.12
0.12	—	4.32	4.50	5.34	5.45	5.58	5.58	5.09

\*  $\tau = 0$  taken as time when heater current was applied.

## 5. DISCUSSION OF RESULTS

Figure 3 shows that, in general, the surge front from the two-dimensional collapse of a rectangle accelerates to a value of  $U$  which is practically independent of the height to semi-base ratio,  $n^2$ .

The maximum values of  $U$  deduced from this figure are:

$n^2$	$a$ (inches)	$U$ (max.)
1	$2\frac{1}{4}$	1.62
1	$4\frac{3}{8}$	1.66
2	$2\frac{1}{4}$	1.71
4	$1\frac{1}{8}$	1.62

This implies that the maximum surge velocity is proportional to the square root of the original column height. The approximate theory neglecting vertical accelerations (part III) leads to a value of 2 for  $U(\text{max.})$ .

A theoretical solution obtained by a relaxation method has been obtained for the  $n^2 = 1$  rectangular section (see part III). The solution is confined to the early motion and figure 7 compares the experimental and theoretical results on the assumption that motion began,

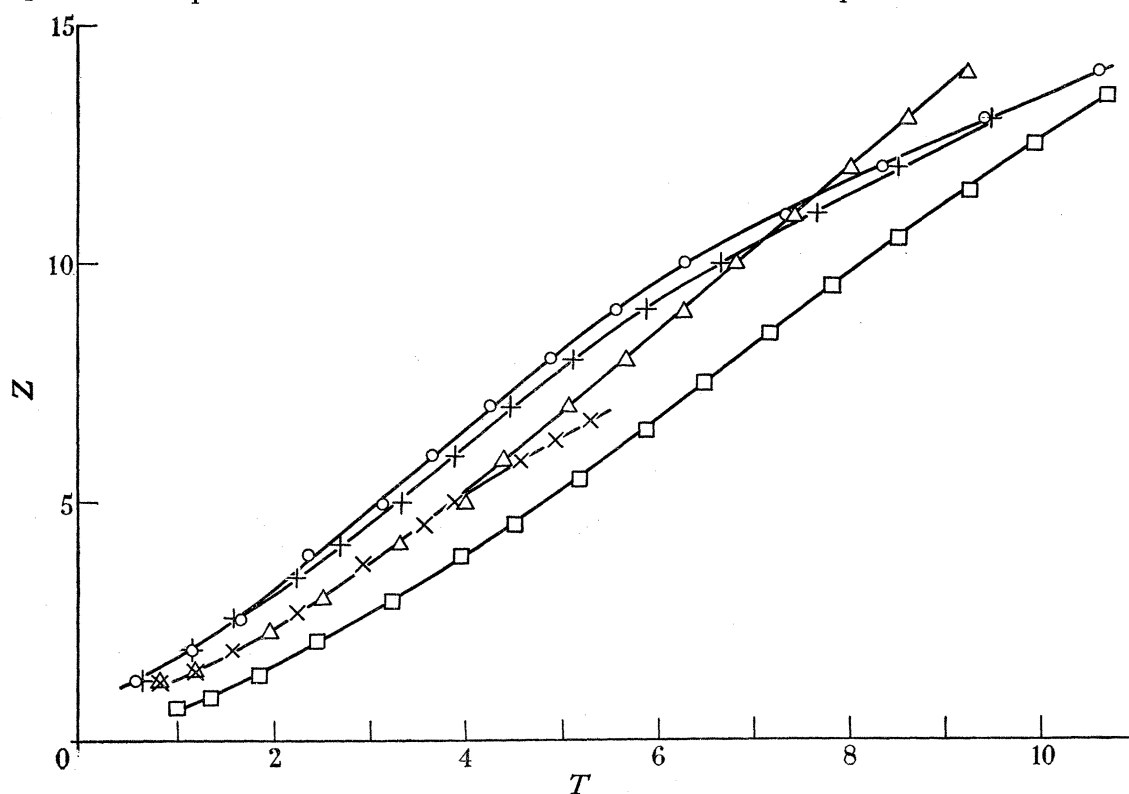

FIGURE 3. Rectangular sections.

key	+	o	x	△	□
$n^2$	1	1	2	2	4
$a$ (in.)	$2\frac{1}{4}$	$4\frac{1}{2}$	$1\frac{1}{8}$	$2\frac{1}{4}$	$1\frac{1}{8}$

Note. In the case of  $n^2 = 4$ ,  $Z/2$  is plotted against  $T/2$ .

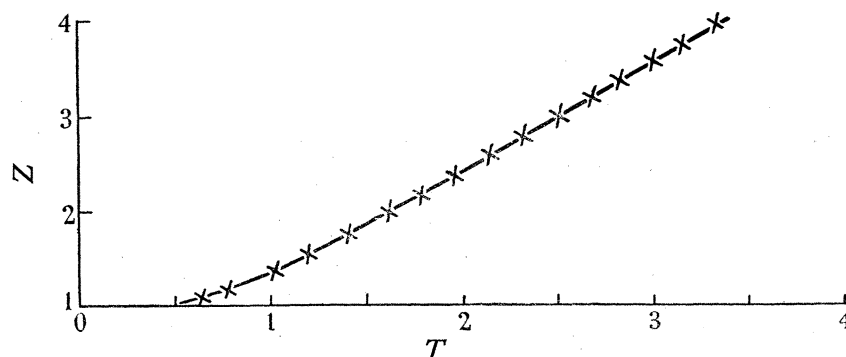

FIGURE 4. Semicircular section.

in the experiments, at a  $T$  of 0.10 after current application, a not impossible circumstance. The agreement is reasonably good in view of the admitted shortcomings of the experimental method and the fact that the relaxation solution becomes less reliable for points near the horizontal plane. Similarities also appear in comparing the contours of the collapsing fluid with the profiles deduced from relaxation theory.



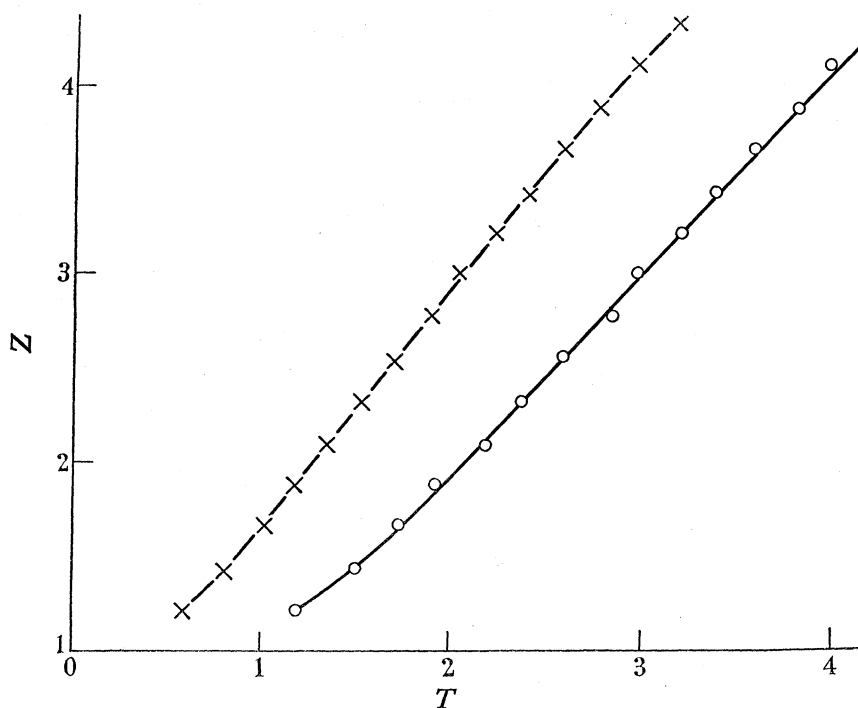

FIGURE 5. Vertical cylinders. +,  $n^2 = 1$ ;  $a = 2\frac{1}{4}$  in. o,  $n^2 = 2$ ;  $a = 2\frac{1}{4}$  in.

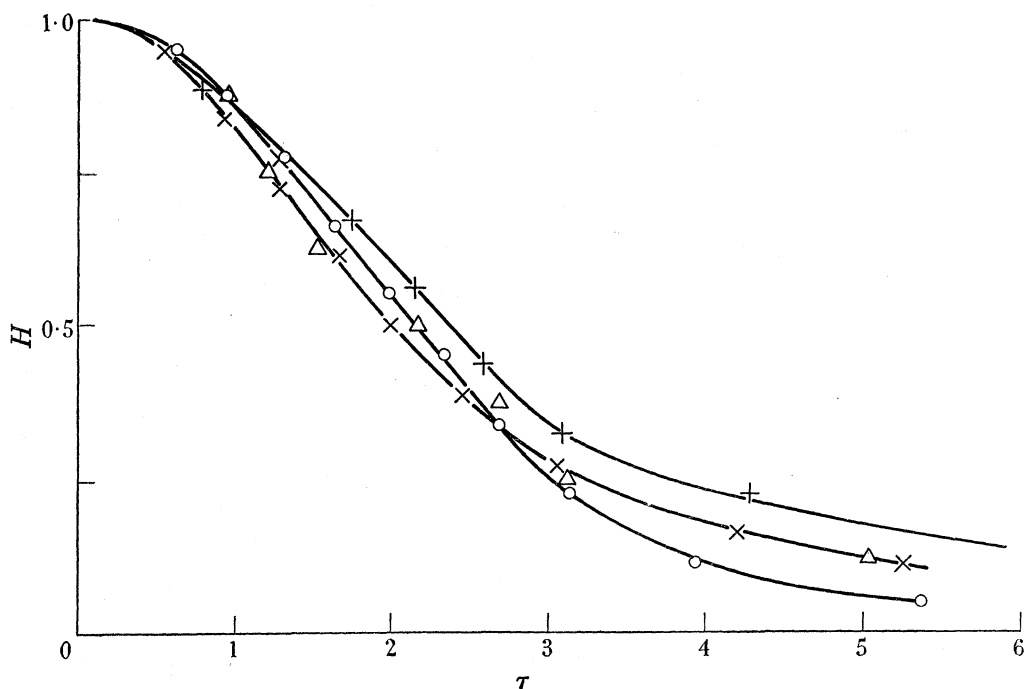

FIGURE 6

	$n^2$	$a$ (in.)	
+	1	$2\frac{1}{4}$	} rectangular section
x	2	$2\frac{1}{4}$	
o	4	$1\frac{1}{8}$	
△	—	2	} semicircular section

Considering figure 3 in more detail, it is seen that little change resulted in doubling the scale of the  $n^2 = 1$  rectangle, although it is true that the thickness of the section remained unchanged. There are indications that the acceleration to the maximum velocity may be

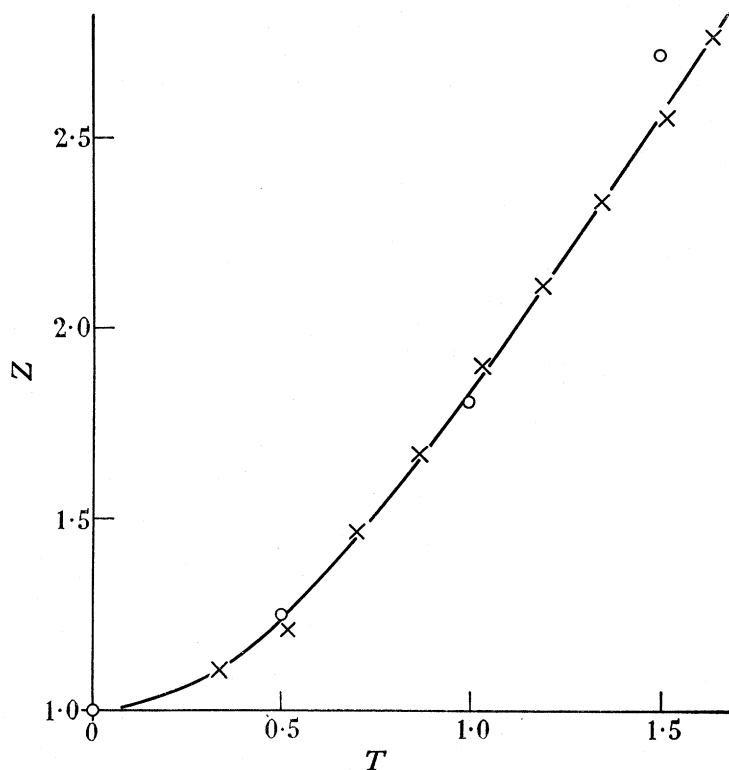

FIGURE 7. Rectangular section,  $n^2 = 1$ :  $\times$ , experiment;  $\circ$ , theory (relaxation solution).

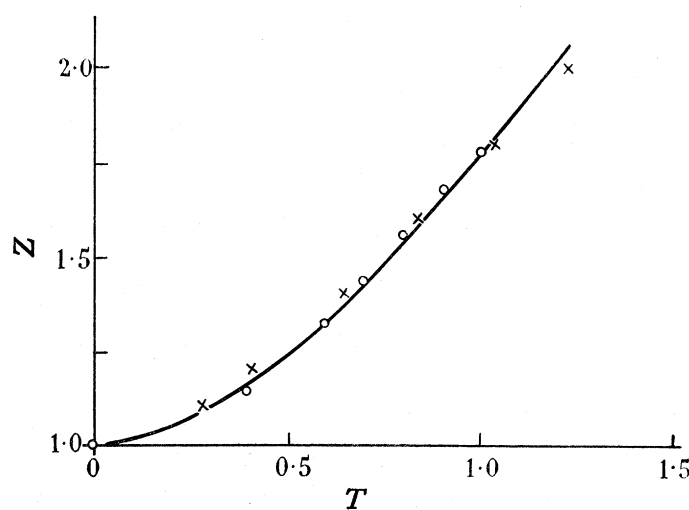

FIGURE 8. Semicircular section:  $\times$ , experiment;  $\circ$ , theory.

greater (in terms of non-dimensional units) at the larger scale, but the effect is not large. In both cases the velocity is seen to slacken off when  $Z$  exceeds 8. Whether this effect would vanish at larger scales is not clear from the experiments. For  $n^2 = 2$  sections, increasing the value of ' $a$ ' from  $1\frac{1}{8}$  to  $2\frac{1}{4}$  in. eliminated, up to  $Z$  of 14 the retardation observed on the

smaller scale when  $Z$  exceeded 5. With  $n^2 = 4$  and  $a = 1\frac{1}{8}$  in. the retardation is not apparent until  $Z$  is greater than about 20.

Results for the semicircular section do not go far enough to establish a value for a maximum velocity. The main reason for including this shape was to check the sufficiency of the spherical harmonic theoretical solution (part III) which did not extend beyond  $Z = 1.8$ . The experimental and theoretical results are compared in figure 8. The results are seen to be in line if the motion in the experiments is taken to have begun at a  $T$  of 0.37 after current application. This could well have been the case, since no disturbance of the fluid was apparent at this  $T$ .

Experimental and theoretical profiles showed similarities, including that in respect of the crossover positions of the original and collapsing contours. The two crossover points subtend an angle at the centre of the semicircle, which is about  $130^\circ$  according to theory and about  $120^\circ$  according to experiment.

The experiments with the semicircular shape employed the full semicircle, so that a diaphragm had to be released from both ends of the section. The observed motion, being symmetrical about the theoretical plane of symmetry, gave reason to believe that the diaphragms were unlikely to be influencing the nature of the bulk motion unduly.

In the experiments simulating the collapse of vertical cylinders, the maximum recorded values of  $U$  are not equal for  $n^2 = 1$  and  $n^2 = 2$  shapes, the shorter cylinder giving a maximum  $U$  of 1.27 and the taller 1.07. It is possible that at larger values of  $Z$  a higher  $U$  for the  $n^2 = 2$  column would have been recorded. It is, however, clear that the maximum  $U$  would not attain the value of 1.65 appropriate to the two-dimensional cases.

The plot, for cases of plane symmetry, of  $H$  against  $\tau$  ( $= T/n$ ) gives the curves shown in figure 6. The curves, and the points for the semicircular section, all occupy the same domain of the graph and it appears that the maximum slope is about the same for each, giving  $|dH/d\tau| = 0.25$ . As far as can be judged, the relaxation solution for an  $n^2 = 1$  rectangle (appendix to part III) gives a value of 0.24. The implication of the experiments is that the maximum downward velocity of the crest of the column is proportional to the square root of the product of the original height and the height to base ratio. The theory neglecting vertical accelerations predicts proportionality to the square root of the original height alone, but it is not to be expected that this theory would be applicable to such an early stage of the motion.

It seems improbable that the residual column would have sufficient momentum to follow through and give the two-dimensional equivalent of the anchor ring appearance of the Bikini surge.

The authors wish to thank Mr D. J. L. Keeble for his assistance in the experimental work. They are indebted to Dr W. G. Penney, F.R.S., for his encouragement of the investigation and to the Chief Scientist, Ministry of Supply, for permission to publish.



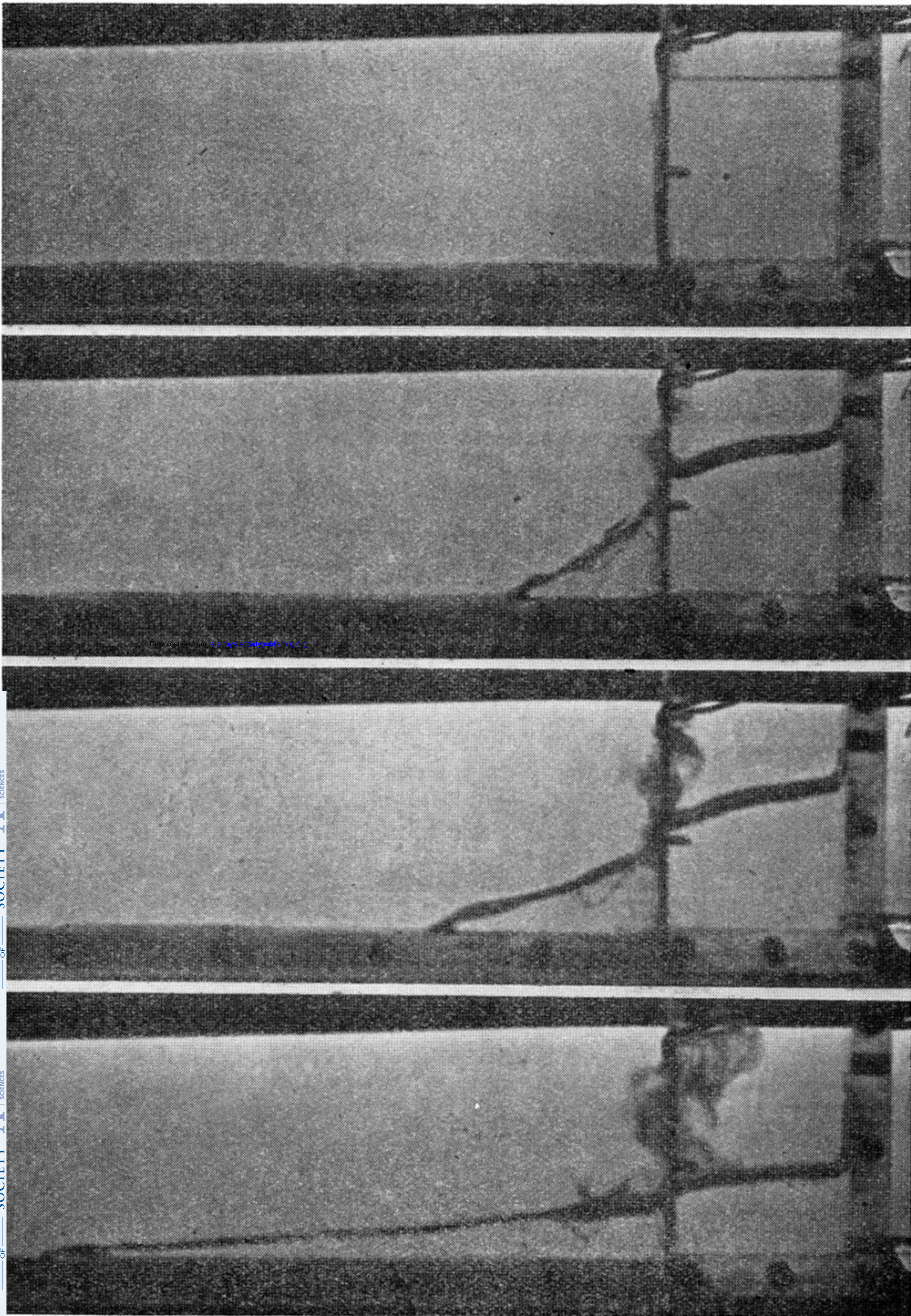

FIGURE 2. Two dimensional collapse of  $n^2 = 1$  section.